

Strain Gages for General Stress Measurement

●General-purpose Foil Strain Gages in KFG Series

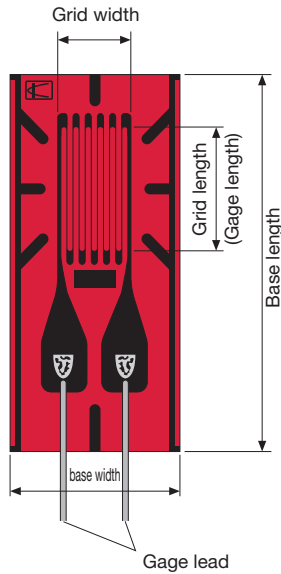

The KFG series gages use polyimide resin for the base approximately 13 μm thick, ensuring excellent flexibility. Besides indoor measurement, the outstanding moisture resistance lets them effectively perform outdoor measurement. Unless directly exposed to waterdrops, no coating treatment is required.

Applicable Adhesives and Operating Temperature Range after Curing

- CC-33A : -196~120°C (-10 to 80°C with vinyl-coated cable attached)
- CC-35 : -30~120°C (-10 to 80°C with vinyl-coated cable attached)
- CC-36 : -30~100°C (-10 to 80°C with vinyl-coated cable attached)
- EP-34B : -55~150°C (-10 to 80°C with vinyl-coated cable attached)
- PC-600 : -196~150°C (-10 to 80°C with vinyl-coated cable attached)

Notes on pre-attached leadwire cables

- Standard color of the 2-wire cable pre-attached to uniaxial gages is red (R). If desired, a white, green, yellow or black cable can be pre-attached.
- Standard 3-wire cable pre-attached to uniaxial gages has red stripes. If desired, the red stripes can be changed to blue or yellow stripes.
- In the case of a triaxial gage, 2-wire cables are color-coded with red, white and green stripes for 0°, 90° and 45°, respectively and 3-wire cables, with red, yellow and blue stripes for 0°, 90° and 45°, respectively. The letter code is S in common.

■Types, lengths and codes of leadwire cables pre-attached to KFG series gages

Type	Polyester-coated 2-wire copper cable	Polyester-coated 3-wire copper cable	Vinyl-coated flat 2-wire cable		Vinyl-coated flat 3-wire cable		Middle-temperature 2-wire cable	Middle-temperature 3-wire cable
Length	C1,C2,C3, C15,C16, D1,D2D3,D4, D6,D9,D16, D17,D19,D28, D29,D31	C1,C2,C3, C15,C16, D1,D4, D16,D17,	C1,C2,C3, D9,D19,	D1,D4, D16,D17, D28,D29, D39	C1,C2,C3, C15,C16, D2,D9,D19, D31	D1,D4, D16,D17, D28,D39	C1,C2,C3, C15,C16, D1,D4,D9, D16,D17,D19, D28,D39	C1,C2,C3, C15,C16, D1,D2,D4,D9, D16,D17,D19, D28,D31,D39
2 cm	N2C2	N2C3						
3	N3C2	N3C3						
4	N4C2	N4C3						
5	N5C2	N5C3						
10	N10C2	N10C3						
15	N15C2	N15C3	L15C2R	L15C2S	L15C3R	L15C3S	R15C2	R15C3
30	N30C2	N30C3	L30C2R	L30C2S	L30C3R	L30C3S	R30C2	R30C3
50	N50C2	N50C3	L50C2R	L50C2S	L50C3R	L50C3S	R50C2	R50C3
1 m	N1M2	N1M3	L1M2R	L1M2S	L1M3R	L1M3S	R1M2	R1M3
2			L2M2R	L2M2S	L2M3R	L2M3S	R2M2	R2M3
3			L3M2R	L3M2S	L3M3R	L3M3S	R3M2	R3M3
4			L4M2R	L4M2S	L4M3R	L4M3S	R4M2	R4M3
5			L5M2R	L5M2S	L5M3R	L5M3S	R5M2	R5M3
6			L6M2R	L6M2S	L6M3R	L6M3S	R6M2	R6M3
7			L7M2R	L7M2S	L7M3R	L7M3S	R7M2	R7M3
8			L8M2R	L8M2S	L8M3R	L8M3S	R8M2	R8M3
9			L9M2R	L9M2S	L9M3R	L9M3S	R9M2	R9M3
10			L10M2R	L10M2S	L10M3R	L10M3S	R10M2	R10M3
15			L15M2R	L15M2S	L15M3R	L15M3S	R15M2	R15M3
20			L20M2R	L20M2S	L20M3R	L20M3S	R20M2	R20M3
25			L25M2R	L25M2S	L25M3R	L25M3S	R25M2	R25M3
30m			L30M2R	L30M2S	L30M3R	L30M3S	R30M2	R30M3
Org. temp. range	-196 to 150°C		-10~80°C				-100~150°C	
Remarks	Twisted for 50-cm and 1-m long (with some exception)		L-6, L-9 for 6 m or longer		L-7, L-10 for 6 m or longer		L-11	L-12

When ordering, suffix the leadwire cable code to the model number with a space in between.

Examples











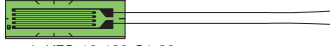

- KFG-5-120-C1-11 N10C3 for the gage with a polyester-coated 3-wire copper cable 10 cm long → [KFG-5-120-C1-11 N10C3](#)
- KFG-5-120-C1-11 L5M2R for the gage with a vinyl-coated flat 2-wire cable 5 m long → [KFG-5-120-C1-11 L5M2R](#)
- KFG-5-120-D17-11 L5M3S for the gage with a vinyl-coated flat 3-wire cable 5 m long → [KFG-5-120-D17-11 L5M3S](#)
- KFG-5-120-C1-11 R5M3 for the gage with a middle-temperature 3-wire cable 5 m long → [KFG-5-120-C1-11 R5M3](#)
- KFG-5-120-D17-11 R5M2 for the gage with a middle-temperature 2-wire cable 5 m long → [KFG-5-120-D17-11 R5M2](#)

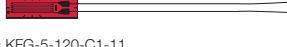
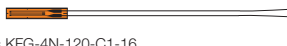
If no leadwire cable code is suffixed, the gage is delivered with gage leads only (silver-clad copper wires 25 mm long)

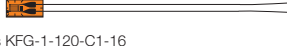

For the types of leadwire cables, refer to page 1-17.

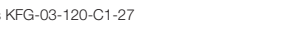



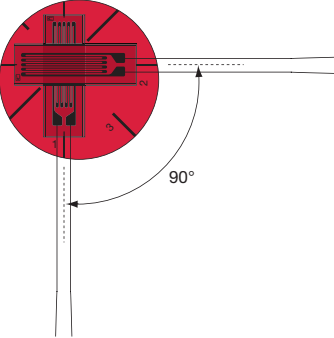
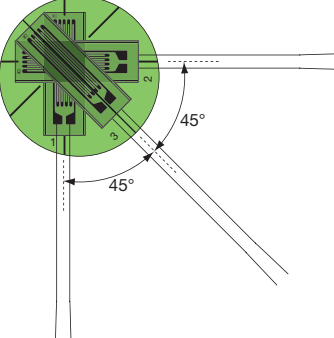
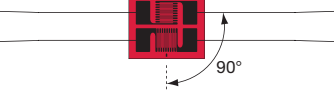

Pattern, Gage Resistance, Gage Factor	Model	Corresponds to the Material Base color	Dimensions (mm)				Remarks
			Grid		Base		
			Length	Width	Length	Width	
Uniaxial							
Silver-clad copper gage leads 25mm long Resistance : 120Ω, Gage factor: Approx. 2.1							
<ul style="list-style-type: none"> ● Common steel ● Stainless steel ● Aluminum ● Magnesium alloy <p>(Linear expansion coefficient based on the base color to distinguish)</p>							
KFG-30-120-C1  ※Figure is KFG-30-120-C1-11	KFG-30-120-C1-11	●	30	3.3	37	5.2	
	KFG-30-120-C1-16	●					
	KFG-30-120-C1-23	●					
	KFG-30-120-C1-27	●					
KFG-20-120-C1  ※Figure is KFG-20-120-C1-16	KFG-20-120-C1-11	●	20	5	28	8	
	KFG-20-120-C1-16	●					
	KFG-20-120-C1-23	●					
	KFG-20-120-C1-27	●					
KFG-10-120-C1  ※Figure is KFG-10-120-C1-23	KFG-10-120-C1-11	●	10	3	16	5.2	
	KFG-10-120-C1-16	●					
	KFG-10-120-C1-23	●					
	KFG-10-120-C1-27	●					
KFG-6-120-C1  ※Figure is KFG-6-120-C1-27	KFG-6-120-C1-11	●	6	1.7	10	3.4	
	KFG-6-120-C1-16	●					
	KFG-6-120-C1-23	●					
	KFG-6-120-C1-27	●					
KFG-5-120-C1  ※Figure is KFG-5-120-C1-11	KFG-5-120-C1-5	●	5	1.4	9.4	2.8	For lumber
	KFG-5-120-C1-11	●					
	KFG-5-120-C1-16	●					
	KFG-5-120-C1-23	●					
KFG-4N-120-C1  ※Figure is KFG-4N-120-C1-16	KFG-4N-120-C1-11	●	4	0.7	8	1.4	
	KFG-4N-120-C1-16	●					
	KFG-4N-120-C1-23	●					
	KFG-4N-120-C1-27	●					
KFG-3-120-C1  ※Figure is KFG-3-120-C1-23	KFG-3-120-C1-11	●	3	1.3	7.4	2.8	
	KFG-3-120-C1-16	●					
	KFG-3-120-C1-23	●					
	KFG-3-120-C1-27	●					
KFG-2-120-C1  ※Figure is KFG-2-120-C1-27	KFG-2-120-C1-5	●	2	1.2	6.3	2.8	For lumber
	KFG-2-120-C1-11	●					
	KFG-2-120-C1-16	●					
	KFG-2-120-C1-23	●					
KFG-2N-120-C1  ※Figure is KFG-2N-120-C1-11	KFG-2N-120-C1-11	●	2	0.84	5.3	1.4	
	KFG-2N-120-C1-16	●					
	KFG-2N-120-C1-23	●					
	KFG-2N-120-C1-27	●					
KFG-1-120-C1  ※Figure is KFG-1-120-C1-16	KFG-1-120-C1-11	●	1	1.1	4.8	2.4	
	KFG-1-120-C1-16	●					
	KFG-1-120-C1-23	●					
	KFG-1-120-C1-27	●					
KFG-1N-120-C1  ※Figure is KFG-1N-120-C1-23	KFG-1N-120-C1-11	●	1	0.65	4.2	1.4	
	KFG-1N-120-C1-16	●					
	KFG-1N-120-C1-23	●					
	KFG-1N-120-C1-27	●					
KFG-03-120-C1  ※Figure is KFG-03-120-C1-27	KFG-03-120-C1-11	●	0.3	1.4	3.5	2.4	
	KFG-03-120-C1-16	●					
	KFG-03-120-C1-23	●					
	KFG-03-120-C1-27	●					
KFG-02-120-C1  ※Figure is KFG-02-120-C1-11	KFG-02-120-C1-11	●	0.2	1.4	3.3	2.4	
	KFG-02-120-C1-16	●					
	KFG-02-120-C1-23	●					
	KFG-02-120-C1-27	●					



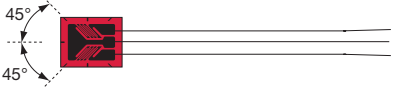
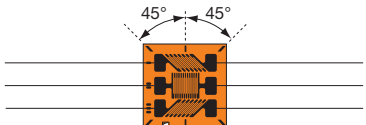
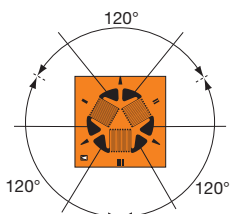
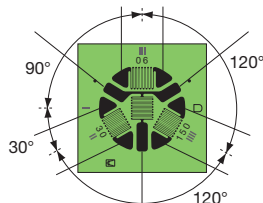

Pattern, Gage Resistance, Gage Factor	Model	Corresponds to the Material Base color	Dimensions (mm)				Remarks
			Grid		Base		
			Length	Width	Length	Width	
Biaxial, 0°/90° stacked rosette Resistance : 120Ω , Gage factor: Approx. 2.1 	KFG-10-120-D16-11	●	10	3	φ21		
	KFG-10-120-D16-16	●					
	KFG-10-120-D16-23	●					
	KFG-10-120-D16-27	●	5	1.4	φ11		
	KFG-5-120-D16-11	●					
	KFG-5-120-D16-16	●					
	KFG-5-120-D16-23	●					
	KFG-5-120-D16-27	●	3	1.3	φ10		
	KFG-3-120-D16-11	●					
	KFG-3-120-D16-16	●					
	KFG-3-120-D16-23	●					
	KFG-3-120-D16-27	●	2	1.2	φ8		
	KFG-2-120-D16-11	●					
	KFG-2-120-D16-16	●					
	KFG-2-120-D16-23	●					
KFG-2-120-D16-27	●	1	1.1	φ5			
KFG-1-120-D16-11	●						
KFG-1-120-D16-16	●						
KFG-1-120-D16-23	●						
KFG-1-120-D16-27	●						
※Figure is KFG-10-120-D16-11							
Triaxial, 0°/90°/45° stacked rosette for Stress Analysis Resistance : 120Ω , Gage factor: Approx. 2.1 	KFG-10-120-D17-11	●	10	3	φ21		
	KFG-10-120-D17-16	●					
	KFG-10-120-D17-23	●					
	KFG-10-120-D17-27	●	5	1.4	φ11		
	KFG-5-120-D17-11	●					
	KFG-5-120-D17-16	●					
	KFG-5-120-D17-23	●					
	KFG-5-120-D17-27	●	3	1.3	φ10		
	KFG-3-120-D17-11	●					
	KFG-3-120-D17-16	●					
	KFG-3-120-D17-23	●					
	KFG-3-120-D17-27	●	2	1.2	φ8		
	KFG-2-120-D17-11	●					
	KFG-2-120-D17-16	●					
	KFG-2-120-D17-23	●					
KFG-2-120-D17-27	●	1	1.1	φ5			
KFG-1-120-D17-11	●						
KFG-1-120-D17-16	●						
KFG-1-120-D17-23	●						
KFG-1-120-D17-27	●						
※Figure is KFG-10-120-D17-23							
Biaxial, 0°/90° plane arrangement Resistance : 120Ω , Gage factor: Approx. 2.1 	KFG-2-120-D1-11	●	2	3.2	10 8.5		
	KFG-2-120-D1-16	●					
	KFG-2-120-D1-23	●					
	KFG-2-120-D1-27	●					
※Figure is KFG-2-120-D1-11							
Biaxial, 0°/90° for Torque Resistance : 120Ω Gage factor: Approx. 2.1 	KFG-2-120-D2-11	●	2	3.4	12 7		
	KFG-2-120-D2-16	●					
	KFG-2-120-D2-23	●					
	KFG-2-120-D2-27	●					
※Figure is KFG-2-120-D2-11							



Pattern, Gage Resistance, Gage Factor	Model	Corresponds to the Material End color	Dimensions (mm)				Remarks
			Grid		Base		
			Length	Width	Length	Width	
Biaxial, 0°/90° for Torque Resistance : 120Ω , Gage factor: Approx. 2.1 	KFG-2-120-D31-11 KFG-2-120-D31-16 KFG-2-120-D31-23 KFG-2-120-D31-27	● ● ● ●	2	1.2	8	6.5	
※Figure is KFG-2-120-D31-11							
Triaxial, 0°/90°/45° Resistance : 120Ω , Gage factor: Approx. 2.1 	KFG-2-120-D3-11 KFG-2-120-D3-16 KFG-2-120-D3-23 KFG-2-120-D3-27	● ● ● ●	2	3.6	11	11	
※Figure is KFG-2-120-D3-16							
Triaxial, 0°/120°/240° Resistance : 120Ω , Gage factor: Approx. 2.1 	KFG-2-120-D4-11 KFG-2-120-D4-16 KFG-2-120-D4-23 KFG-2-120-D4-27 KFG-1-120-D4-11 KFG-1-120-D4-16 KFG-1-120-D4-23 KFG-1-120-D4-27	● ● ● ● ● ● ● ●	2	3.4	12	12	
※Figure is KFG-2-120-D4-16			1	1.7	7	7	
Quadraxial, 0°/30°/90°/150° Resistance : 120Ω , Gage factor: Approx. 2.1 	KFG-2-120-D6-11 KFG-2-120-D6-16 KFG-2-120-D6-23 KFG-2-120-D6-27	● ● ● ●	2	3.4	17	17	
※Figure is KFG-2-120-D6-23							
Uniaxial, with lead at both ends Resistance : 120Ω , Gage factor: Approx. 2.1 	KFG-1-120-C2-11 KFG-1-120-C2-16 KFG-1-120-C2-23 KFG-1-120-C2-27	● ● ● ●	1	1.8	5.6	3	
※Figure is KFG-1-120-C2-27							
	KFG-1-120-C3-11 KFG-1-120-C3-16 KFG-1-120-C3-23 KFG-1-120-C3-27	● ● ● ●	1	1.8	5.5	2.7	
※Figure is KFG-1-120-C3-27							

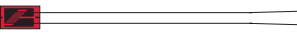
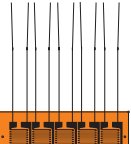
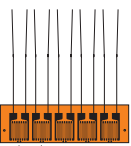
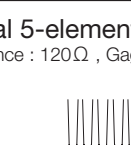
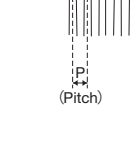
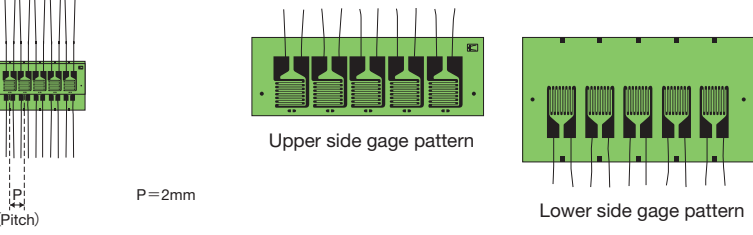



Pattern, Gage Resistance, Gage Factor	Model	Corresponds to the Material End color	Dimensions (mm)				Remarks
			Grid		Base		
			Length	Width	Length	Width	
Uniaxial, for shearing strain Resistance : 120Ω, Gage factor: Approx. 2.1							
Torque measurement is possible by using C15 and C16 in combination.							
 ※Figure is KFG-2-120-C15-11	KFG-2-120-C15-11	●	2	0.8	5.2	3	
	KFG-2-120-C15-16	●					
	KFG-2-120-C15-23	●					
	KFG-2-120-C15-27	●					
 ※Figure is KFG-2-120-C16-11	KFG-2-120-C16-11	●	2	0.8	5.2	3	
	KFG-2-120-C16-16	●					
	KFG-2-120-C16-23	●					
	KFG-2-120-C16-27	●					
Uniaxial 5-element, for concentrated stress measurement Resistance : 120Ω, Gage factor: Approx. 2.1							
 P = 3 mm for gage length 2 mm P = 2 mm for gage length 1 mm ※Figure is KFG-2-120-D9-16 N10C2	KFG-2-120-D9-11 N10C2	●	2	2.2	17	5	A minimum quantity 5 piece
	KFG-2-120-D9-16 N10C2	●					
	KFG-2-120-D9-23 N10C2	●					
	KFG-2-120-D9-27 N10C2	●					
	KFG-1-120-D9-11 N10C2	●					
 P = 3 mm for gage length 2 mm P = 2 mm for gage length 1 mm ※Figure is KFG-2-120-D19-16 N10C2	KFG-1-120-D9-16 N10C2	●	1	1.4	12	4	A minimum quantity 5 piece
	KFG-1-120-D9-23 N10C2	●					
	KFG-1-120-D9-27 N10C2	●					
	KFG-1-120-D9-11 N10C2	●					
 P = 3 mm for gage length 2 mm P = 2 mm for gage length 1 mm ※Figure is KFG-2-120-D19-16 N10C2	KFG-2-120-D19-11 N10C2	●	2	2.5	17	5	A minimum quantity 5 piece
	KFG-2-120-D19-16 N10C2	●					
	KFG-2-120-D19-23 N10C2	●					
	KFG-2-120-D19-27 N10C2	●					
	KFG-1-120-D19-11 N10C2	●					
 P = 3 mm for gage length 2 mm P = 2 mm for gage length 1 mm ※Figure is KFG-2-120-D19-16 N10C2	KFG-1-120-D19-16 N10C2	●	1	1.5	12	4	A minimum quantity 5 piece
	KFG-1-120-D19-23 N10C2	●					
	KFG-1-120-D19-27 N10C2	●					
	KFG-1-120-D19-11 N10C2	●					
Biaxial 5-element, for concentrated stress measurement Resistance : 120Ω, Gage factor: Approx. 2.1							
 P=2mm Upper side gage pattern Lower side gage pattern ※Figure is KFG-1-120-D39-23 N10C2	KFG-1-120-D39-11 N10C2	●	1	1.4 (1.5)	12	6.4	Figures in parentheses are for lower side gages.
	KFG-1-120-D39-16 N10C2	●					
	KFG-1-120-D39-23 N10C2	●					
	KFG-1-120-D39-27 N10C2	●					
Uniaxial 60Ω gages Resistance : 60Ω, Gage factor: Approx. 2.1							
 ※Figure is KFG-5-60-C1-27	Use 2 gages in parallel connection (bending compensation possible).						
	KFG-5-60-C1-11	●	5	2	10	3.4	
	KFG-5-60-C1-16	●					
	KFG-5-60-C1-23	●					
	KFG-5-60-C1-27	●					
	 ※Figure is KFG-5-60-C1-27	KFG-2-60-C1-11	●	2	2.3	7.2	3.7
KFG-2-60-C1-16		●					
KFG-2-60-C1-23		●					
	KFG-2-60-C1-27	●					

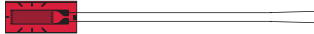
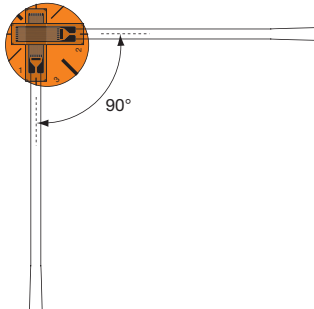
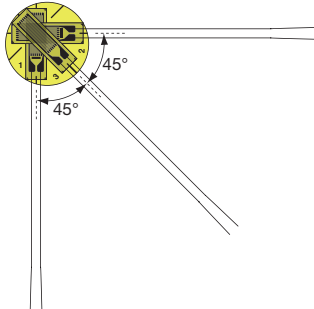

Pattern, Gage Resistance, Gage Factor	Model	Corresponds to the Material End color	Dimensions (mm)				Remarks
			Grid		Base		
			Length	Width	Length	Width	
Uniaxial 350Ω gages							
Resistance : 350Ω, Gage factor: Approx. 2.1							
	KFG-5-350-C1-11	●	5	2	9.4	4.2	
	KFG-5-350-C1-16	●					
	KFG-5-350-C1-23	●					
	KFG-5-350-C1-27	●					
	KFG-3-350-C1-11	●					
	KFG-3-350-C1-16	●	3	2	7.4	4.2	
	KFG-3-350-C1-23	●					
	KFG-3-350-C1-27	●					
	KFG-2-350-C1-11	●	2	2	6.3	4.2	
	KFG-2-350-C1-16	●					
	KFG-2-350-C1-23	●					
	KFG-2-350-C1-27	●					
	KFG-1-350-C1-11	●	1	2	4.8	3.4	
	KFG-1-350-C1-16	●					
	KFG-1-350-C1-23	●					
	KFG-1-350-C1-27	●					
※Figure is KFG-5-350-C1-11							
Biaxial 350Ω gages, 0°/90° stacked rosette							
Resistance : 350Ω, Gage factor: Approx. 2.1							
	KFG-5-350-D16-11	●	5	2	φ11		
	KFG-5-350-D16-16	●					
	KFG-5-350-D16-23	●					
	KFG-5-350-D16-27	●					
	KFG-3-350-D16-11	●					
	KFG-3-350-D16-16	●	3	2	φ10		
	KFG-3-350-D16-23	●					
	KFG-3-350-D16-27	●					
	KFG-2-350-D16-11	●	2	2	φ10		
	KFG-2-350-D16-16	●					
	KFG-2-350-D16-23	●					
	KFG-2-350-D16-27	●					
	KFG-1-350-D16-11	●	1	1.8	φ8		
	KFG-1-350-D16-16	●					
	KFG-1-350-D16-23	●					
	KFG-1-350-D16-27	●					
※Figure is KFG-5-350-D16-16							
Triaxial 350Ω gages, 0°/90°/45° stacked rosette							
Resistance : 350Ω, Gage factor: Approx. 2.1							
	KFG-5-350-D17-11	●	5	2	φ11		
	KFG-5-350-D17-16	●					
	KFG-5-350-D17-23	●					
	KFG-5-350-D17-27	●					
	KFG-3-350-D17-11	●					
	KFG-3-350-D17-16	●	3	2	φ10		
	KFG-3-350-D17-23	●					
	KFG-3-350-D17-27	●					
	KFG-2-350-D17-11	●	2	2	φ10		
	KFG-2-350-D17-16	●					
	KFG-2-350-D17-23	●					
	KFG-2-350-D17-27	●					
	KFG-1-350-D17-11	●	1	1.8	φ8		
	KFG-1-350-D17-16	●					
	KFG-1-350-D17-23	●					
	KFG-1-350-D17-27	●					
※Figure is KFG-5-350-D17-27							

A minimum quantity 10 piece

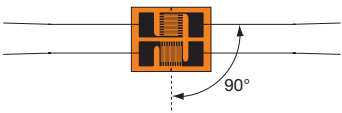
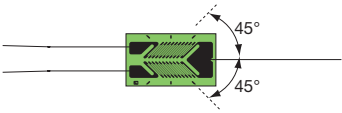
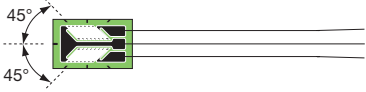

Pattern, Gage Resistance, Gage Factor	Model	Corresponds to the Material End color	Dimensions (mm)				Remarks
			Grid		Base		
			Length	Width	Length	Width	
Biaxial 350Ω gages, 0°/90° Resistance : 350Ω, Gage factor: Approx. 2.1 	KFG-2-350-D1-11 KFG-2-350-D1-16 KFG-2-350-D1-23 KFG-2-350-D1-27	● ● ● ●	2	3	10	8.5	
※Figure is KFG-2-350-D1-26							
Biaxial 350Ω gages for torque, 0°/90° Resistance : 350Ω, Gage factor: Approx. 2.1 	KFG-2-350-D2-11 KFG-2-350-D2-16 KFG-2-350-D2-23 KFG-2-350-D2-27	● ● ● ●	2	4	12	6.8	
※Figure is KFG-2-350-D2-23							
	KFG-2-350-D31-11 KFG-2-350-D31-16 KFG-2-350-D31-23 KFG-2-350-D31-27	● ● ● ●	2	3	10.5	6.5	
※Figure is KFG-2-350-D2-23							
Uniaxial 500Ω gages for transducers Resistance : 500Ω, Gage factor: Approx. 2.1 	KFG-5-500-C1-11 KFG-5-500-C1-16 KFG-5-500-C1-23 KFG-5-500-C1-27	● ● ● ●	5	3.5	11	4.9	
※Figure is KFG-5-500-C1-27							
	KFG-2-500-C1-11 KFG-2-500-C1-16 KFG-2-500-C1-23 KFG-2-500-C1-27	● ● ● ●	2	2.6	7.5	4.4	
Uniaxial 1000Ω gages for transducers Resistance : 1000Ω, Gage factor: Approx. 2.1 ※Figure is KFG-10-120-D17-23 	KFG-5-1K-C1-11 KFG-5-1K-C1-16 KFG-5-1K-C1-23 KFG-5-1K-C1-27	● ● ● ●	5	3.5	11	4.9	
※Figure is KFG-5-1K-C1-27							
	KFG-2-1K-C1-11 KFG-2-1K-C1-16 KFG-2-1K-C1-23 KFG-2-1K-C1-27	● ● ● ●	2	3	7.2	4.5	



Pattern, Gage Resistance, Gage Factor	Model	Corresponds to the Material End color	Dimensions (mm)				Remarks
			Grid		Base		
			Length	Width	Length	Width	

●KFG Series Foil Strain Gages with Gage Terminal

Uniaxial

Resistance : 120Ω, Gage factor : Approx. 2.1



T-C26

(When the clip-equipped dedicated cable is used, the operating temperature range of each adhesive after curing is -10 to 80°C.)

※Figure is KFG-2-120-C1-11 T-F7

KFG gages equipped with a gage terminal enable one touch connection/disconnection of the leadwire cable. They are suitable for residual stress measurement with the cutting method. A clip equipped dedicated cable T-C26 (vinyl-coated, 2 m long) is optionally available.

Applicable Adhesives and Operating Temperature Range after Curing

PC-600 : -196~150°C CC-33A : -196~120°C
 -196~150°C CC-35 : -30~120°C
 CC-36 : -30~100°C

KFG-2-120-C1-11 T-F7	●	2	1.2	6.3	2.8
KFG-2-120-C1-16 T-F7	●				
KFG-2-120-C1-23 T-F7	●				
KFG-1-120-C1-11 T-F7	●	1	1.1	4.8	2.4
KFG-1-120-C1-16 T-F7	●				
KFG-1-120-C1-23 T-F7	●				

Biaxial, 0°/90° stacked rosette

Resistance : 120Ω, Gage factor : Approx. 2.1

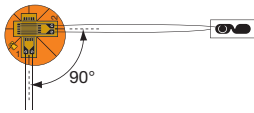

※Figure is KFG-2-120-D16-16 T-F7

KFG-2-120-D16-11 T-F7	●	2	1.2	φ8
KFG-2-120-D16-16 T-F7	●			
KFG-2-120-D16-23 T-F7	●			
KFG-1-120-D16-11 T-F7	●	1	1.1	φ5
KFG-1-120-D16-16 T-F7	●			
KFG-1-120-D16-23 T-F7	●			

Triaxial, 0°/90°/45° stacked rosette

Resistance : 120Ω, Gage factor : Approx. 2.1

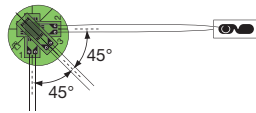

※Figure is KFG-2-120-D17-23 T-F7

KFG-2-120-D17-11 T-F7	●	2	1.2	φ8
KFG-2-120-D17-16 T-F7	●			
KFG-2-120-D17-23 T-F7	●			
KFG-1-120-D17-11 T-F7	●	1	1.1	φ5
KFG-1-120-D17-16 T-F7	●			
KFG-1-120-D17-23 T-F7	●			

●KFG Series Foil Strain Gages for Boring Method

Triaxial, 0°/135°/90°

Resistance : 120Ω, Gage factor : Approx. 2.1

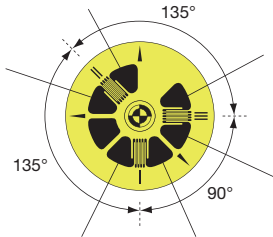

For KFG gages with the leadwire cable pre-attached, refer to page 1-13.

※Figure is KFG-3-120-D28-27

Designed to measure residual stress released through the boring method.

Applicable Adhesives and Operating Temperature Range after Curing

CC-33A : -196~120°C EP-34B : -55~150°C
 CC-35 : -30~120°C PC-620 : -196~150°C
 CC-36 : -30~100°C

KFG-3-120-D28-11	●	3	2	φ19.8	Bore diameter 3
KFG-3-120-D28-16	●				
KFG-3-120-D28-23	●				
KFG-3-120-D28-27	●	1.5	1.3	φ12	Bore diameter 1.5
KFG-1.5-120-D28-11	●				
KFG-1.5-120-D28-16	●				
KFG-1.5-120-D28-23	●				
KFG-1.5-120-D28-27	●				

●KFG Series Foil Strain Gages for Measuring Axial Tension of Bolts

Uniaxial

Resistance : 120Ω

Gage factor : Approx. 1.9

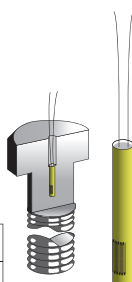

L	KFG-3 : 2.5mm
	KFG-1.5 : 1.75mm

If it is difficult to bond a strain gage to the surface of a bolt for measuring the tightening stress, these gages enable the measurement by embedding into a hole, 2 mm diameter, bored through the top head of the bolt. They are applicable to materials having a linear expansion coefficient of 11μm/m °C.

Applicable Adhesives and Operating Temperature Range after Curing

EP-18 Normal temperature to 50°C A minimum quantity 5 piece
 EP-34B Normal temperature to 50°C

KFG-3-120-C20-11	3	app. 6	11.5	φ1.9	Bore diameter 2
KFG-1.5-120-C20-11	1.5	app.6	5	φ1.9	Bore diameter 2

For further information please contact:

TEST MACHINES AUSTRALIA
 0418 369 505
 sales@testmachines.com.au
 www.testmachines.com.au

A minimum quantity 10 piece